

RIFFEL

GIPFEL DES ERFOLGS

www.riffelappliances.de

VACUUM CLEANER

INSTRUCTION MANUAL

BLIZZARD

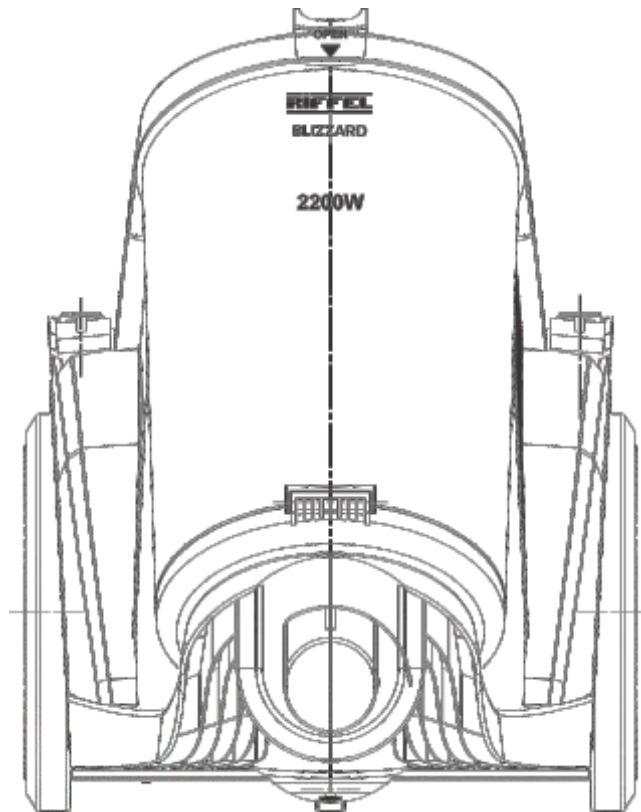

PLEASE READ THE MANUAL CAREFULLY BEFORE USING AND KEEP IT PROPERLY FOR FUTURE USE

Instruction Manual Vacuum Cleaner

VCM43A14V-A 220-240V 50/60Hz 1800W



Jiangsu Midea Chunhua Electric Appliance Co., Ltd
Address: Litanghe Road, XiangCheng Economy
Development Zone, XiangCheng District,
Suzhou 215131, China

STRUCTURE OF THE PRODUCT

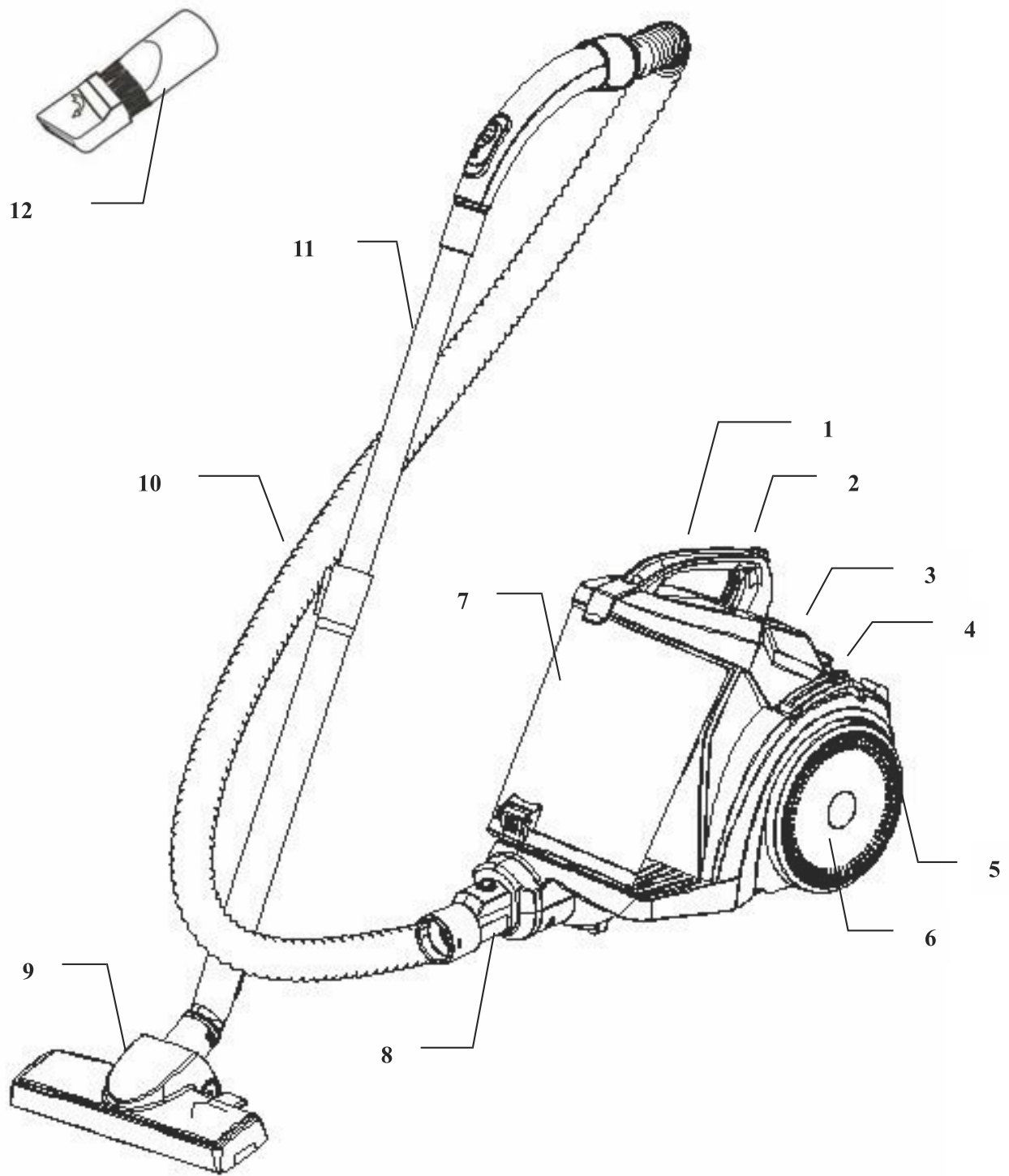

1	handle	7	Dust cup
2	Release button	8	Hose connector
3	Power button	9	Brush tool
4	Cord rewind button	10	Hose
5	Rubber for big wheel	11	Extending metal tube
6	Big wheel	12	Two in one brush

Safety Direction

1. For the first operation, it is advisable to read the manual carefully before hand and keep it properly for future use.
2. Before the first operation, make sure the dust cup is properly installed.
3. Make sure the power supply is 220-240V 50Hz
4. Do not vacuum water and inflammable material
5. Do not vacuum burning material and ashes
6. Do not use the machine without a motor protection filter filled
7. Disconnect power before changing attachments, removing dust container and maintaining appliance.
8. Please change the dust cup/HEPA immediately when it is damaged.
9. Do not store or use the machine close to high temperature places
10. Do not let children use the machine in case of any danger
11. If abnormal noise, smell, smoke or any other failure or breakage was found during the operation, you should turn off the switch and unplug it. Then contact with your service center for repair. Do not repair it by yourself.
12. If the supply cord is damaged, it must be replaced by the manufactures or its service agent or a similarly qualified person in order to avoid a hazard

HOW TO USE

ASSEMBLY BEFORE USE

Fig.1 shows the connection of the hose and the vacuum cleaner:

Put the hose connector in front of the vacuum cleaner .Then insert it into the inlet hole . If you want to disassemble it, you can press the release button and then pull it out.

Fig.2 shows the connection of the hose and the extending metal tube:

Hold the flexural connector of the hose and put it into the bigger hole of the tube.

Fig.3 shows the connection of the tube and the brush tool:

Put the metal tube into the hole of the brush and rotate it to fasten them.

Fig.4 shows how to check the winding of the power cord.

You can pull the power cord out of the machine and stop it when you see the yellow mark. Make sure the red mark is not out. When your sweep is over, first turn off the power, pull the plug out of the socket, and then push the winding device button until the cord is completely in the machine.

Fig.5 shows the power button

Put the plug into the socket, push the power button to control the work of the machine.



Fig.1



Fig.2

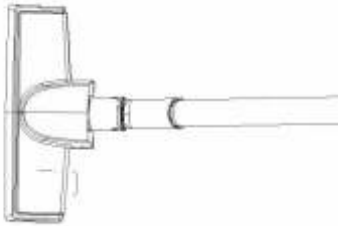

Fig.3



Fig.4

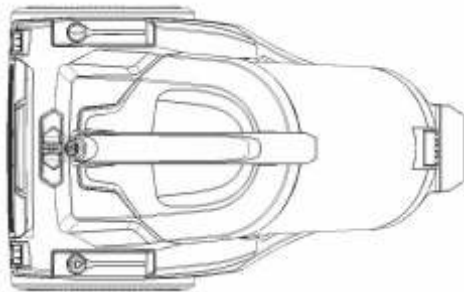

Fig.5

CLEANING OF THE DUST CUP

The steps of the dust cup cleaning:

1. As in Fig.6, hold the dust cup and handle and push the release button.
2. As in Fig.7, take the dust cup out of the machine.
3. As in Fig.8, put the dust cup onto the rubbish bin, push the release button to open the bottom of the dust cup, and the dirt and dust will fall into the bin by themselves.
4. As in Fig.9, shut up the dust cup for a circular use after your cleaning.

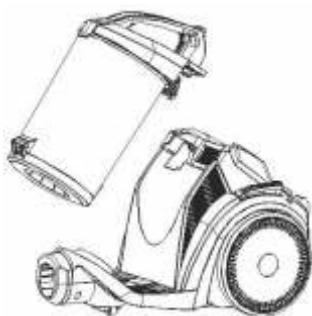

Fig.6

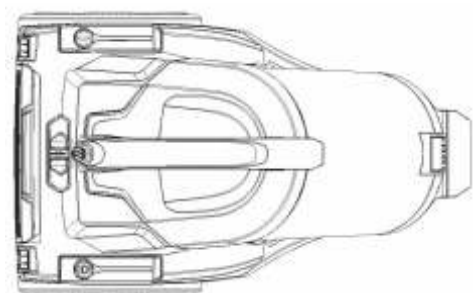

Fig.7



Fig.8



Fig.9

ATTACHMENTS

HOW TO USE THE ATTACHMENTS:

1. As in fig.10, you can use the two in one brush in the corner and the aperture.
2. As in fig.11, open the other side with bristles of the two in one brush as the mark of an arrow to clean the sofa, the curtain and the dust on the ornaments.
3. As in fig.12, tread on the pedal of the brush tool to let the bristles out, and you can clean the floor.
4. As in fig.13, tread on the pedal of the brush tool again to put the bristles in, and you can clean the carpet.

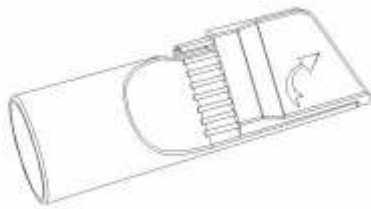

Fig.10

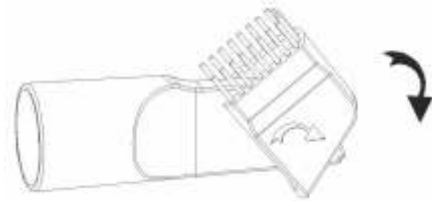

Fig.11

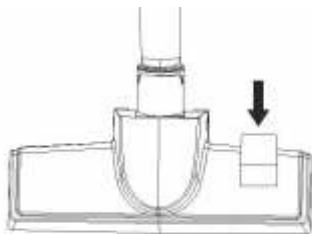

Fig.12

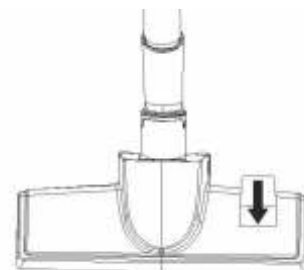

Fig.13

MAINTENANCE

HOW TO MAINTAIN

1. The filter should be cleaned twice a year, and when there is obvious dirt on the filter, it is time.
2. You must fix the filter properly before running the vacuum cleaner.
3. The filter can't be cleaned in the washing machine or baked by the blower.
4. It will reduce the suction power and damage the motor if you use the wet filter.
5. Steps for maintenance:
 - 1) As in fig.14, press the outlet lock to open the outlet board.
 - 2) As in fig.15, get out the outlet filter.

- 3) As in fig.16, rotate the HEPA cover to separate it from the dust cup cover
- 4) As in fig.17, get the HEPA cover
- 5) As in fig.18, take the filter out and tap it to remove the dust. If necessary, you can rinse it under water tap.
- 6) Wash the HEPA cover, the HEPA assembly, the outlet sponge and the dust chamber in the water without detergent and dry them before use. Don't use any tools to brush the HEPA filter paper, otherwise the HEPA filter will be damaged and filtration effect will be affected.
- 7) Fix the HEPA assembly on the chamber cover and make sure three salient cubes should be stuck in the grooves of the dust chamber.
- 8) Rotate the HEPA assembly in the direction of the mark on the chamber cover.
- 9) Assemble the chamber cover assembly and the dust chamber according to the mark outside.
- 10) Put the dust chamber assembly into the machine. And in this process, first you should make the chamber in the right position and then press the handle of the dust chamber, if there is a cluck it means the operation is successful.

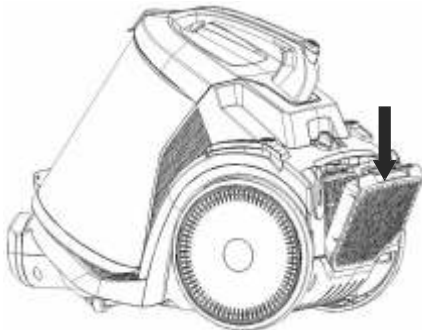

Fig.14



Fig.15

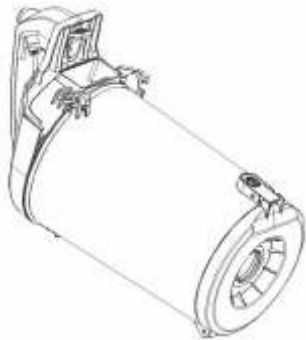

Fig.16



Fig.17



Fig.18



This marking indicates that this product should not be disposed with other household wastes throughout the EU. To prevent possible harm to the environment or human health from uncontrolled waste disposal, recycle it responsibly to promote the sustainable reuse of material resources. To return your used device, please use the return and collection systems or contact the retailer where the product was purchased. They can take this product for environmental safe recycling.

RIFFEL
GIPFEL DES ERFOLGS